

SHORT STROKE PNEUMATIC CYLINDERS - LO-Profile® SERIES MA-SE-FM

Metric-Double Acting-Single Ended Pistons-Side Ported-Either Face Mounted

Ports are M3 straight threads with spotface for flat gasket fitting.

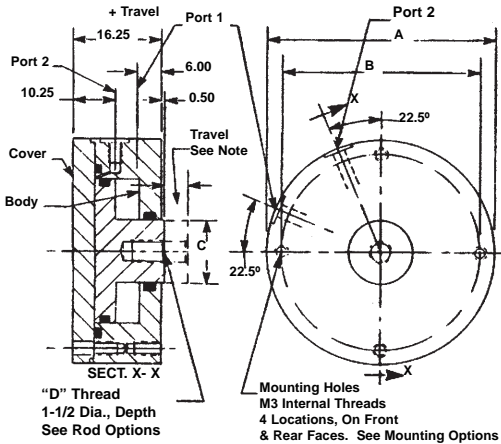

SPECIFICATIONS:

SERVICE, PLANT AIR
M.O.P., 20 BAR OR 2000KPa
TEMPERATURE, -40°C to +120°C

MATERIALS:

BODY & COVER, ALUMINUM ALLOY
PISTON, ALUMINUM ALLOY
SEALS, VITON O RINGS
FASTENERS, ALLOY STEEL

NOTES:

Dimensions are nominal in METRIC specifications.

An air/oil mist unit is recommended for internal lubrication. Where such units are not practical, SERVICE KITS including seals & factory approved lube are available.

Cylinders may also be used in low pressure hydraulic and vacuum service.

Wrench flats may not be necessary if cylinders can be pressurized in the retracted or extended position while tightening the rod joint.

Inquiries regarding modifications to BASIC CYLINDERS are always welcome.

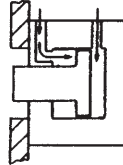

Pictorial

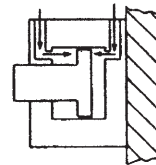

Pictorial

BASIC PART No.	O.D. A	Bolt Circle B	Rod Dia. C	Rod Thd. D	WR. Flats E	Depth F	Length G	Off Set H	Ream J	Width K	Width L	Piston O.D.	Extend Area (sq.mm.)	Retract Area (sq.mm.)
M5201(-)	35	27.5	9	M5	7	8	10	4	3	3	5	15	176.6	113.1
M5202(-)	40	32.5	10	M6	8	10	12	5	4	4	6	20	314.2	235.6
M5203(-)	45	37.5	10	M6	8	10	12	5	4	4	6	25	490.8	412.3
M5204(-)	50	42.5	10	M6	8	10	12	5	4	4	6	30	706.9	628.3
M5205(-)	55	47.5	15	M8	12	15	17	7	5	5	8	35	962.1	785.4
M5206(-)	60	52.5	15	M8	12	15	17	7	5	5	8	40	1256.6	1079.9

OPTIONAL PORTS

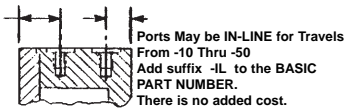

HOW TO ORDER BASIC CYLINDERS

A BASIC PART NUMBER consists of a letter and four digits followed by a dash number to indicate piston travel in increments of 2.5mm. Travel to -50 (50mm) is standard. Please consult the Factory for longer travel.

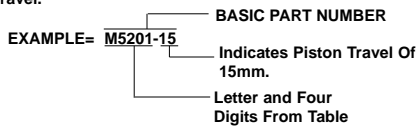

HOW TO ORDER CYLINDERS WITH OPTIONS

Add options to the BASIC PART NO. as suffixes in any order.

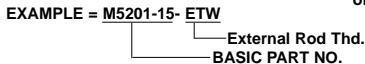

HOW TO ORDER CYLINDERS WITH STAINLESS STEEL PISTONS.

Add the letter -S as a prefix to the BASIC PART NO. Add 25% to the BASE PRICE.

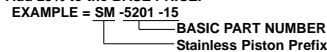

HOW TO ORDER ALL STAINLESS STEEL CYLINDERS

Add the letter -SS as a prefix to the BASIC PART NO. Add 25% to the BASE PRICE.

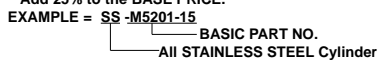

OPTIONAL ROD ENDS

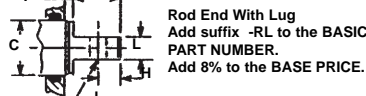
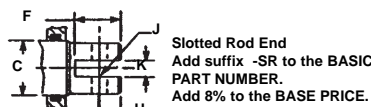
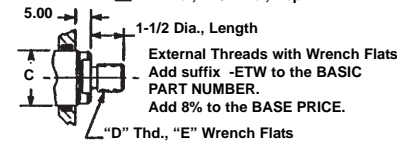
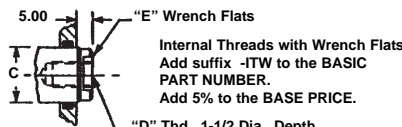

HOW TO ORDER CYLINDERS WITH VITON SEALS

Add suffix -V to the BASIC PART NO. Add 10% to the BASE PRICE

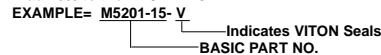

HOW TO ORDER BUNA "N" SERVICE KITS

Specify the BASIC PART NO. followed by suffix -SK.

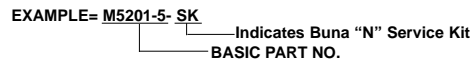

OPTIONAL MOUNTING STYLES

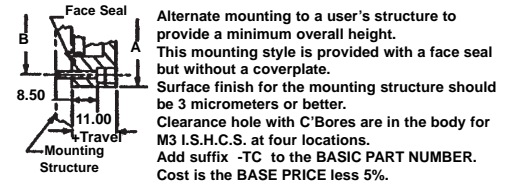
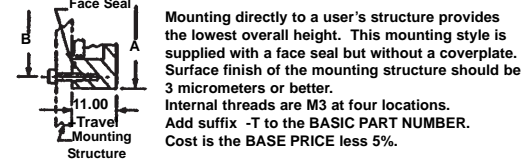
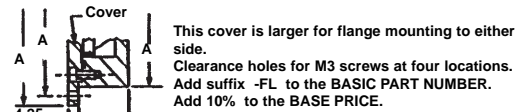
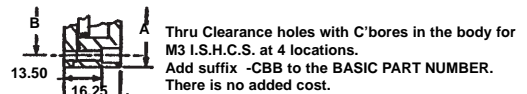
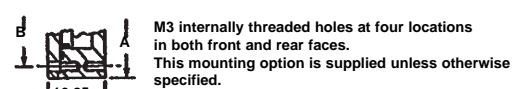

HOW TO ORDER VITON SERVICE KITS

Specify the BASIC PART NO. followed by suffix -VSK.

