

**SHORT STROKE HYDRAULIC ACTUATORS, MINIATURE HI-ENERGY® SERIES 3000-LS-R-STI-SM**  
**Double Acting-Single Ended Pistons-Rectangular Configuration-Side Trepanned Ports-Side Mounted**

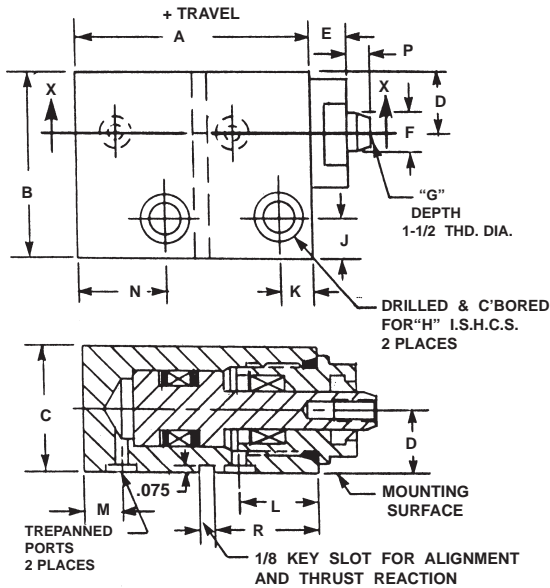

**PRODUCT DETAILS**

BASIC PART NUMBER	A	B	C	D	E	F	G	H	J	K	L	M	N	P	Q	R	S
HS6272(-)-LS	1.800	1.500	1.000	0.500	0.300	0.312	8-32	1/4-28	0.320	0.247	0.650	0.300	0.700	0.105	0.385	0.860	0.685
HS6273(-)-LS	2.200	1.750	1.250	0.625	0.400	0.438	1/4-28	5/16-24	0.320	0.360	0.870	0.330	0.800	0.146	0.426	1.116	0.826
HS6274(-)-LS	2.300	2.000	1.500	0.750	0.400	0.562	5/16-24	3/8-24	0.330	0.372	0.900	0.400	0.850	0.163	0.443	1.127	0.843
HS6275(-)-LS	2.300	2.500	2.000	1.000	0.500	0.750	3/8-24	3/8-24	0.330	0.372	0.900	0.400	0.850	0.220	0.500	1.127	1.000

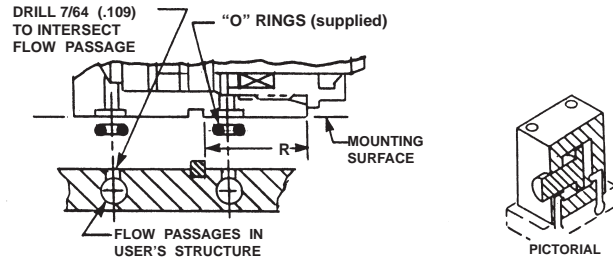

A keyway is recommended in the user's structure for reaction to thrust load and for maintaining alignment.

**SUGGESTED MOUNTING DETAILS:**

**SPECIFICATIONS:**

SERVICE, HYDRAULIC OIL  
M.O.P., 3000 PSI  
TEMPERATURE, -40 TO 275 deg. F  
MATERIALS:

BODY, STAINLESS STEEL  
GUIDE, BEARING BRONZE  
PISTON, STAINLESS STEEL  
ROD SEALS, LIP STYLE  
PISTON HEAD SEAL, "O" RING  
BACKUP RINGS, TEFLON

BASIC PART NUMBER	PISTON DIA. (IN.)	EXT. AREA (SQ.IN.)	RET. AREA (SQ.IN.)
HS6272(-)-LS	0.625	0.307	0.232
HS6273(-)-LS	0.875	0.601	0.453
HS6274(-)-LS	1.125	0.994	0.748
HS6275(-)-LS	1.375	0.485	1.046

**ORDERING INFORMATION:**

**HOW TO ORDER BASIC ACTUATORS**

A BASIC PART NUMBER consists of two letters & four digits followed by a dash number to indicate piston travel in increments of 1/10 (0.100) inch followed by the suffix -LS. Travel to -40 (4.000) is standard.

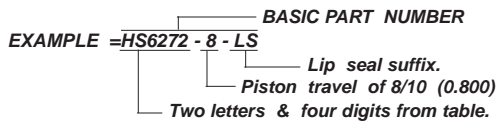

**HOW TO ORDER ACTUATORS WITH OPTIONS**

Add options to a BASIC PART NUMBER as suffixes in any order.

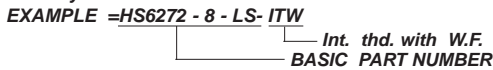

**HOW TO ORDER METRIC VERSIONS**

Add prefix "M" to a BASIC PART NO. and change piston travel to millimeters. Please see inside rear cover for metric travel conversions. There is no added cost for a metric version.

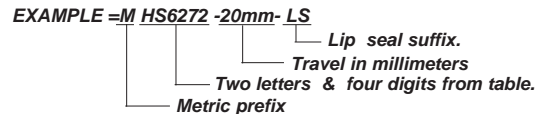

**HOW TO ORDER SEAL KITS**

Specify the COMPLETE PART NUMBER followed by the suffix -SK

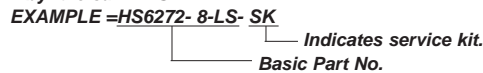

**ROD END OPTIONS:**

Rod end with internal thread "G" and wrench flats.  
Add suffix -ITW to a BASIC PART NUMBER.  
Add 4% to the BASE PRICE.

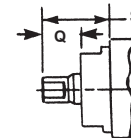

Rod end with external thread "G" and wrench flats.  
Add suffix -ETW to a BASIC PART NUMBER.  
Add 8% to the BASE PRICE.

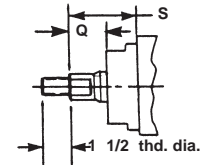

**MOUNTING OPTION:**

Body is threaded internally for mounting with "H" fasteners from below.  
Add suffix -IT to a BASIC PART NO.  
There is no added cost.



**NOTES**

Dimensions are nominal in U.S. Customary specifications. Metric actuators are dimensionally equivalent except for conversion in mounting details where threads, fasteners, clearance holes & counter-bores are to Metric Standards. See inside rear cover for U.S. to Metric thread conversion. There is no added cost for this Metric modification. Wrench flats may not be necessary if actuators can be pressurized in the retracted or extended position when tightening the rod connection. Inquiries regarding modifications to BASIC ACTUATORS are welcome.

